



Proficiency* HMI/SCADA – iFIX*

Make faster, better business decisions by collecting, analyzing and sharing critical production data across your enterprise.

As the level of competition increases in your market, so does the need to continually reduce operating costs and improve production processes wherever possible. Success depends greatly on your ability to access, understand and utilize the volumes of crucial automation information being generated throughout your operation every day.

Many of the largest and most successful companies around the world rely on GE's Proficiency HMI/SCADA – iFIX for the comprehensive monitoring, analysis, control and distribution of their plant-wide data. With applications in industries including pharmaceuticals, biotech, consumer packaged goods, food and beverage, oil and gas, water, waste water, power and others, Proficiency HMI/SCADA – iFIX is the right HMI or SCADA solution for your automation environment.

With the power of leading technologies and patented techniques, Proficiency HMI/SCADA – iFIX is the ultimate tool for visualization, automation and in delivering analytics to drive the lowest possible total cost of ownership.

Technical Benefits

Powerful Distributed, Client/Server Architecture

- Proficiency HMI/SCADA – iFIX SCADAs collect, process and distribute real-time data to Clients
- Clients, including both Thick and Thin offerings
- Client/server architecture delivers unparalleled scalability

Faster System Development and Deployment

- The iFIX Workspace is an intuitive integrated development environment
- Develop and deploy applications quickly using powerful Wizards
- Leverage Office applications like Excel and Word for mass editing and documentation
- Develop and improve applications online, without shutting down operations or recompiling applications
- Key Macro Editor provides powerful and diverse capabilities at the touch of a button
- Animation Experts drive internal and third party ActiveX controls without the need for VBA programming
- Tag Group Editor saves development time and enables display reuse
- Event Scheduler automates tasks running in the foreground or background
- Automation APIs enable programmatic development by major users like OEMs and engineering firms

Application Integration

- iFIX delivers an industry leading ActiveX container for hosting third party objects
- Drop in ActiveX controls and bring them to life using the Animation Expert

(No scripting required)

- Ensure the reliability of your application with our Secure Containment technology
- Integrate your plant floor systems with Relational Databases, MES and ERP systems
- Design a secure system using iFIX local or domain based security, electronic signatures, audit trails, network encryption and ChangeManagement features.
- Proficiency Portal integration object for hosting integrated content from diverse business systems
- Proficiency Historian integration for the ultimate in archival storage
- Proficiency Batch integration and Batch control objects for complex S-88 Batch management

Extensive Functionality

- Windows 2000/XP/2003/Vista based
- SQL/ODBC interfaces for easy integration with relational databases
- Advanced visualization (HMI)
- Math, Logic and Supervisory control (SCADA)
- User and role based node or domain linked security
- Real-time and historical trending
- Manual data collection and data management
- Advanced alarming and alarm management
- High performance and secure networking
- Wizards maximize development productivity
- Discovery and Automatic Configuration Tools
- Graphic Dynamo Management
- Recipe Handling
- Run-time and remote configuration
- ActiveX controls for database connectivity (VisiconX)
- Time and event scheduling
- Microsoft Visual Basic for Applications Integration (VBA)



Proficy* HMI/SCADA – iFIX*

- Certified OPC client and server support
- Object-oriented graphics
- Workspace and an integrated development environment
- Fully Integrated Change Management Capabilities
- Electronic Signatures and Audit Trails (designed for 21 CFR Part 11)
- Biometric Password Support
- Application Integrity Validation
- Advanced Communications, Database and Network Diagnostics
- Redundancy and Validation on High Availability Computing Platforms
- Environment Protection
- Database Block Toolkit for Developers
- Integration Toolkit for Developers
- Installation Scripting and Customization
- Microsoft SMS Capable
- Alarm Emailing through Alarm and Event Express Utility

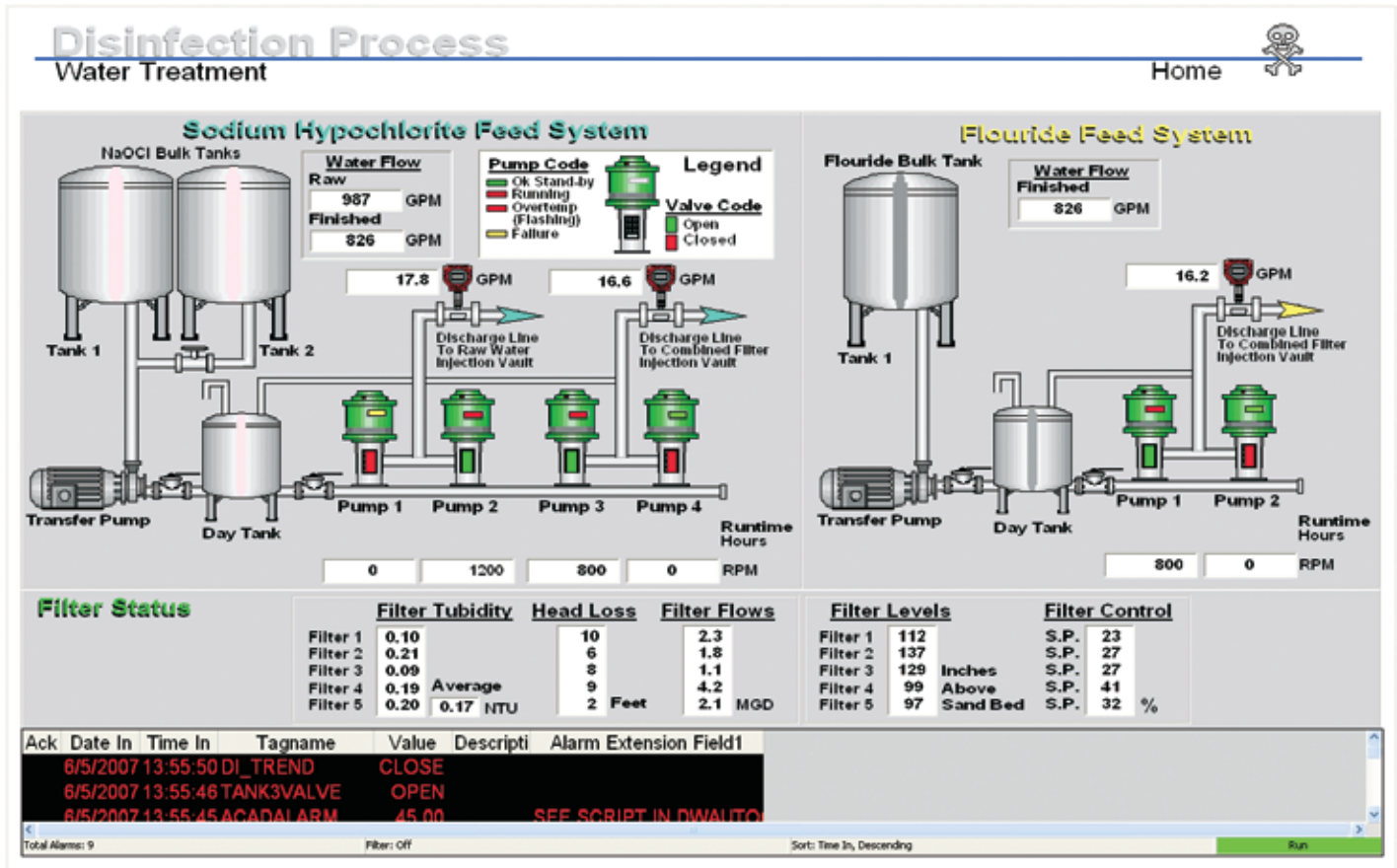

Proficy HMI/SCADA – iFIX graphical tools enable users to develop and deploy applications quickly using powerful wizards.

Business Benefits

Rapid ROI

Proficy HMI/SCADA – iFIX delivers low total cost of ownership because it enables you to:

- Develop and deploy powerful automation solutions faster and easier reducing your up-front engineering costs
- Achieve faster time-to-market with new products due to greater flexibility and ease of implementation
- Increase productivity and product quality through tighter control and better data analysis
- Protect your investments in legacy hardware and software systems through

market leading connectivity

- Reduce your system maintenance and expansion costs by leveraging a large pool of engineering talent, world-wide
- Learn the system faster by leveraging Standards, Experts and Wizards.

A Safe Investment for the Future

Proficy HMI/SCADA – iFIX is an intelligent investment that is equally compatible with a wide range of established and emerging technologies. Because it is designed on open, Microsoft technologies including COM/DCOM, .NET, ActiveX, VBA, ODBC, Windows 2000/XP/2003/Vista and OPC, Proficy

HMI/SCADA – iFIX is a standards based and very flexible solution that can protect your hardware and soft-ware investments, delivering the ability to adapt and expand as your application grows, both now and in the future.

Electronic Signatures and Audit trails

Proficy HMI/SCADA – iFIX is equipped with Electronic Signature collection and logging to an audit trail. Additionally, Biometrics may be applied in lieu of Password entry. Proficy HMI/SCADA – iFIX is the leading choice of manufacturing engineers, operators and system integrators because it delivers the best

Proficy* HMI/SCADA – iFIX*

of both worlds: unmatched ease of use and unlimited flexibility. This offers a variety of tremendous benefits for the end-user:

- Increased data integrity
- Greater operator accountability
- Higher efficiency
- Ideal functionality to help meet FDA 21 CFR Part 11 requirements

- Creates the foundation of a paperless records system
- Greater efficiency in repetitive Signing

Part of an Integrated Enterprise

With Proficy HMI/SCADA – iFIX, you have the power to:

- Integrate real-time data from the plant floor with your business systems

- Exchange real-time information with users and applications throughout the enterprise
- Seamlessly integrate best-in-class software applications with the highest reliability
- Make faster, more effective, more intelligent decisions

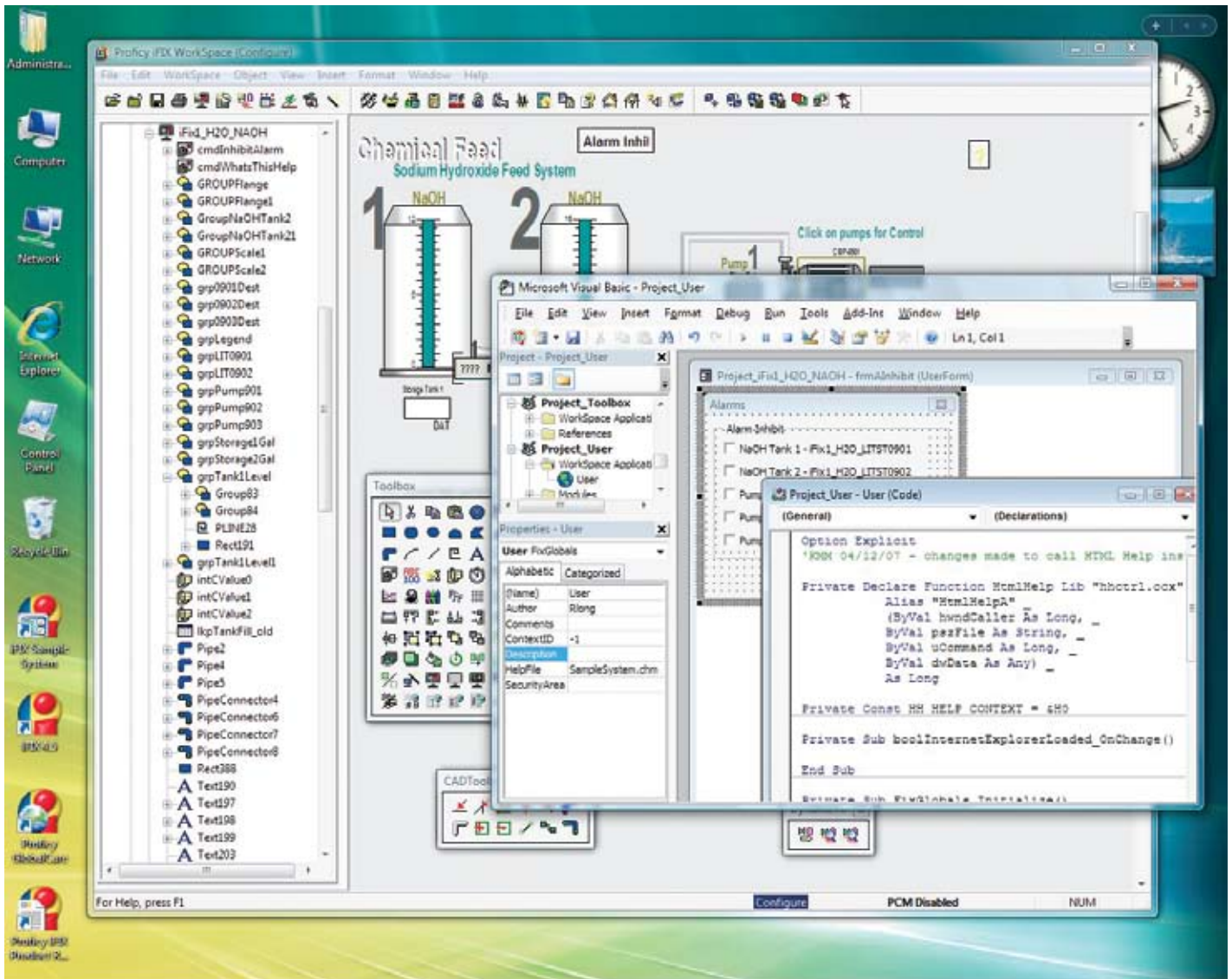

Proficy HMI/SCADA – iFIX is the leading choice of manufacturing engineers, operators and system integrators because it delivers the best of both worlds: unmatched ease of use and unlimited flexibility.

Proficy* HMI/SCADA – iFIX*

Comprehensive Monitoring and Control

GE's Proficy HMI/SCADA – iFIX is a robust HMI/SCADA solution, providing process visualization, data acquisition, analytics and supervisory control of your process. Proficy HMI/SCADA – iFIX gives you the power and security to precisely monitor and control every aspect of your process, as well as your equipment and resources, resulting in faster response to production or process issues; less waste, improved quality, faster time-to-market with new products, and increased profitability.

Proficy HMI/SCADA – iFIX, with its scan based architecture, is an extremely well-suited application for process environments, with functionality to excel in water/waste-water, oil and gas, and regulated industries, particularly those under the FDA's 21 CFR Part 11 rule.

Features

Ease and Flexibility

With its extensive library of intuitive graphical tools, Proficy HMI/SCADA – iFIX enables users to be "up and running" quickly and easily, building a powerful window into their automation system.

Whether you're implementing a single, stand-alone HumanMachine Interface (HMI), or a highly complex, multi-node, multi-site Supervisory Control and Data Acquisition (SCADA) system, Proficy HMI/SCADA – iFIX offers the functionality you need to quickly develop an application of any type and size. And because it's designed with an extremely flexible architecture, Proficy HMI/SCADA – iFIX gives you the power to meet your current application needs, while easily expanding your systems as your business requirements grow.

A Highly Extensible Architecture

Distributed Network Architecture

Proficy HMI/SCADA – iFIX's fully distributed, client/server architecture provides maximum flexibility when designing a system. Deployment possibilities range from a single computer running Proficy HMI/SCADA – iFIX in a stand-alone HMI application to a large, networked system with many distributed servers and clients.

HMI/SCADA Servers

The Proficy HMI/SCADA – iFIX server connects to physical I/O points and maintains the Process Database. A variety of tag types are

available, including analog and digital inputs and outputs, calculations, alarms, totalizers, timers, continuous and statistical control functions, SQL commands, and more. Proficy HMI/SCADA – iFIX applications include real-time graphics, trending, reporting, batch, MES, and many others. Toolkits are available for custom block development.

iClient

iClient is the standard GE thick client. It serves as a traditional PC-based client in that it is installed on the hard disk and accesses data from a local or remote computer. All applications can be run on iClient, including real-time graphics, trending, alarming and reporting. Plus, users can perform development online from each client, including building graphics and adding tags to local or distributed servers.

iClientTS

iClientTS is a thin-client and web solution that makes use of Microsoft Terminal Server technology and provides the full capabilities of a

standard iClient. From any iClientTS station, users have complete access to all networked Proficy HMI/SCADA – iFIX SCADA Servers – making full use of iClient technology, ActiveX controls and VBA and third party content.

Proficy Real-Time Information Portal

Proficy Real-Time Information Portal is another Proficy thin client solution for distributing information to many users. With Proficy Real-Time Information Portal, HMI/SCADA – iFIX graphics are converted and published to a web server. Then, from a web browser, pages are animated with real-time data from SCADA Servers.

Proficy HMI/SCADA – iFIX Architecture Advantage

The Proficy HMI/SCADA – iFIX distributed, client/server architecture incorporates any combination of distributed servers (SCADA Servers) and distributed clients (iClient, iClientTS, and/or iWebServer). To users, Proficy HMI/SCADA – iFIX appears as a single, high-performance integrated system.

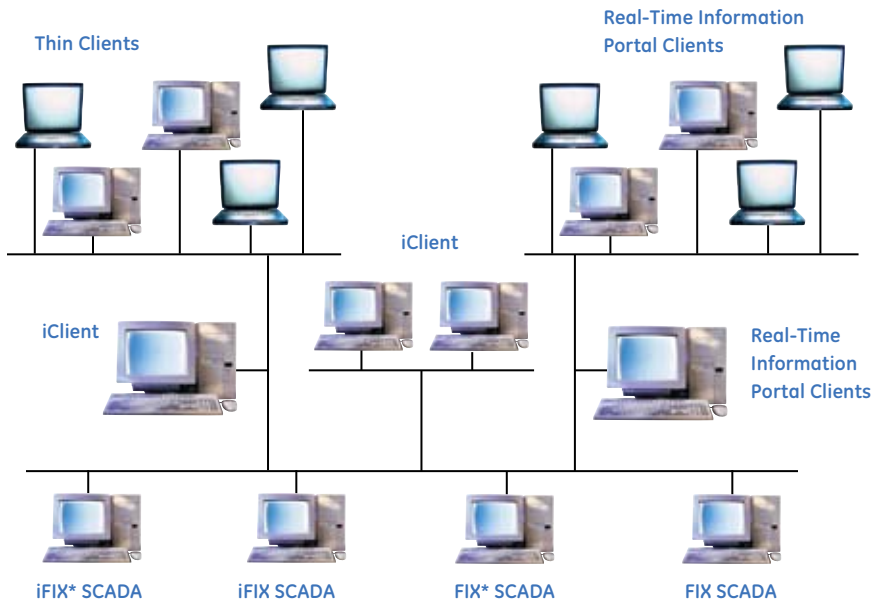

Proficy HMI/SCADA – iFIX System Architecture

Proficy HMI/SCADA – iFIX allows tremendous network configuration flexibility, using a combination of SCADA Servers, or even existing FIX nodes and clients.

Proficy* HMI/SCADA – iFIX*

Building Your HMI/SCADA through the Application

System Tree

The main navigational tool for locating application files in Proficy HMI/SCADA – iFIX is the System Tree. This hierarchical view of an application enables users to easily manipulate Proficy HMI/SCADA – iFIX documents and objects, and quickly launch Proficy HMI/SCADA – iFIX and third-party applications. And because of its completely customizable design, applications, folders and files can be easily added or removed.

Development Toolbox

The Proficy HMI/SCADA – iFIX Development Toolbox contains a complete set of state-of-the-art, customizable drawing tools, Experts and animation objects. You can position the most commonly used tools and buttons anywhere on your picture and resize them as desired, for fast and easy screen development.

Drawing Tools and Objects

For additional flexibility and customization in your screen development, the Toolbox also features an extensive array of drawing tools. From a full range of geometric shapes to features such as buttons, datalinks, charts, alarm summaries and more, the drawing tools let you quickly and easily create graphics, animation and control that precisely suit your needs.

Wizards and Experts

Built-in Wizards and Experts perform both simple and complex tasks, eliminating the need for programming. An extensive set of Toolbox Experts automatically generates powerful VBA (Visual Basic for Applications) scripts so developers can build applications quickly and efficiently.

Objects/Graphic Dynamos

Graphic Dynamos are reusable, animated objects or groups of objects that enable you to create graphics quickly and easily. Graphic Dynamo sets provide a number of pre-defined objects such as tanks and pumps, which can be dropped into the Workspace to save development time. Dynamo management tools enable updates to a Master library to ripple through your applications safely and under complete user control.

Ordinary HMI Simple Networking

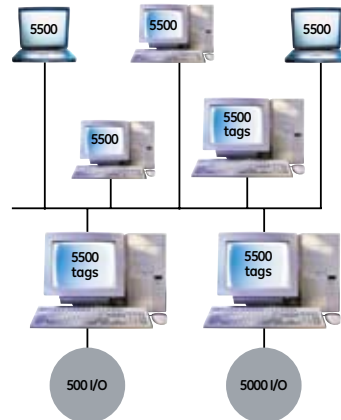

VS.

Proficy HMI/SCADA – iFIX's Distributed, Client/Server Architecture

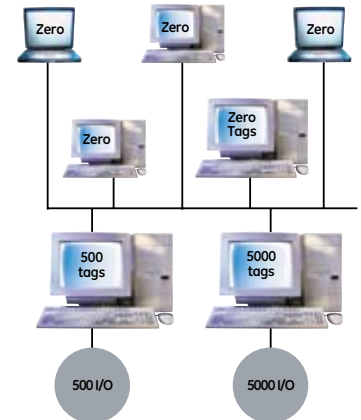

System Architecture Comparison

Unlike ordinary HMI/SCADA software packages designed with simple networking, Proficy HMI/SCADA – iFIX's distributed, client/server architecture allows you to expand your system by simply adding the new server to the network. Adding or changing database tags is easy: you simply make the change at its source, and the data is updated across the system. All data from every node is available to all users across the network. Adding servers and clients to the network is straightforward and predictable, requiring no changes to other nodes in the system.

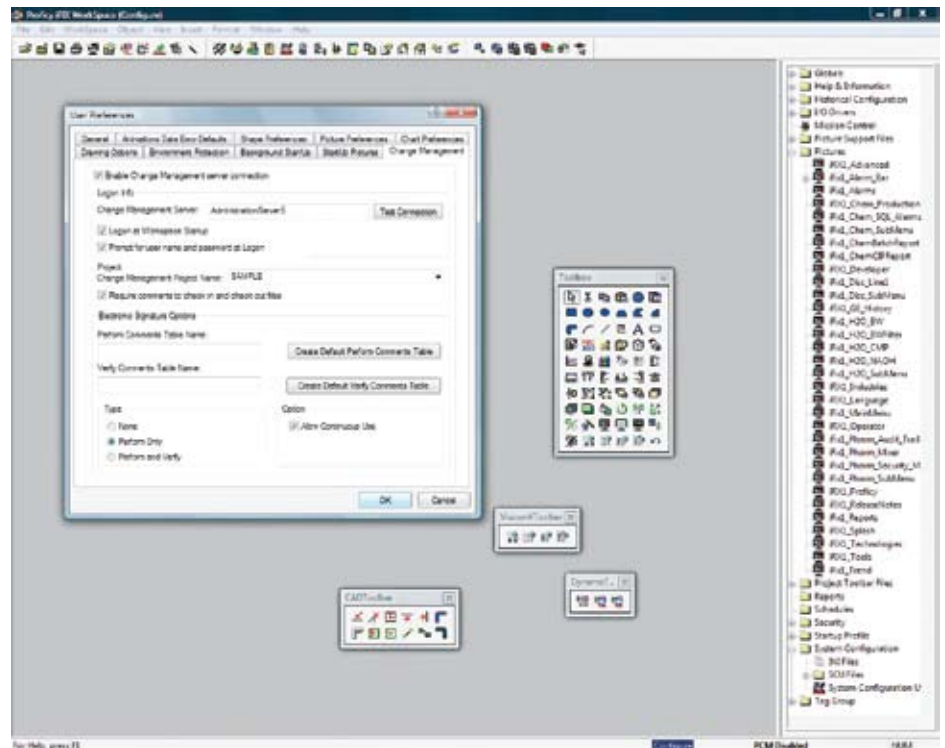

WorkSpace

The Proficy HMI/SCADA – iFIX WorkSpace is a powerful container that provides an easy-to-use development environment. It features a Windows Explorer-style System Tree for easy project navigation and management, as well as a toolbox that contains all drawing tools, wizards and experts.

Proficy* HMI/SCADA – iFIX*

Grouping Objects

Grouping objects is a convenient way to organize and reuse them to accelerate picture development. Users can easily duplicate and manipulate groups of objects to expedite Proficy HMI/SCADA – iFIX application building.

Object Drill Down

In a Proficy HMI/SCADA – iFIX picture, users can modify the properties of objects within a group without separating them, and without losing scripts or animations applied to the group – all without programming.

Drag and Drop

With simple drag and drop ease; graphics can be moved and copied into the WorkSpace, between programs, or among two or more programs.

ActiveX Support

The iFIXWorkSpace is a powerful, secure container for all ActiveX controls, which can be dropped into the WorkSpace for easy integration. In addition, ActiveX documents such as Word and Excel files can be dropped into the WorkSpace with automatic display of their own menus and toolbars.

VisiconX

VisiconX is a unique and powerful set of ActiveX controls for accessing and displaying data from relational databases. With simple point-and-click ease and zero programming, users have immediate access to SQL Server, Oracle, and other relational databases. VisiconX controls embed easily into the WorkSpace, significantly reducing development time.

Object-to-Object Connections

VBA technology is tightly and uniquely embedded into the Proficy HMI/SCADA – iFIX architecture. Applications can be developed without the need for custom code. For example, you can drop a meter ActiveX control into the WorkSpace, connect it to a tag with zero programming, and it is instantly animated.

Tag Groups

Tag groups save valuable development time by reusing portions of an application. For example, when opening or replacing a picture, the tag group file is read, and the symbols in the picture are reconnected with the corresponding substitutions defined in the tag group file. One display may be launched several times, each connected to a different set of data sources.

Event Scheduler

The Event Scheduler acts as a transaction processor, allowing a user to perform tasks at specified times or intervals or triggered

by events. Users can generate a report at the end of a shift or replace a display when a database point exceeds a specified value. For convenience and efficiency, events can be run in the foreground or background. Triggers can run a simple action, or a complex VBA expression.

Key Macros

Key Macros are user-defined key combinations that execute commands during run mode. Key Macros can be associated with Proficy HMI/SCADA – iFIX pictures, or with shapes in a Proficy HMI/SCADA – iFIX picture, or can be system wide. As an added benefit, the Key Macro Editor offers an expert to create and manipulate VBA scripts.

Online Configuration

Patented technology enables Proficy HMI/SCADA – iFIX to be customized online to maximize efficiency. Processes do not need to be stopped, or recompiled, to make changes to the database, pictures, or other parts of the HMI application. And changes can be initiated without having to shut down and restart your system.

Historical Data

Proficy HMI/SCADA – iFIX provides an internal, automatic, comprehensive and long-term “Classic Historian” for sampling, storing, and displaying process data. Historical trending enables users to analyze process trends and post-process data, as well as to archive process variables to meet government regulations. The trending capability also allows

for monitoring changes in product properties and analyzing equipment performance to save time and money. For more advanced applications where higher performance, greater scalability or lower administration is required, Proficy HMI/SCADA – iFIX interfaces with the award winning and market leading Proficy Historian. This powerful combination of two Proficy solutions delivers a unique set of features and benefits that will improve any automation environment.

Chart Object

The Proficy HMI/SCADA – iFIX Chart Object lets you configure any number of historical and real-time pens in the same chart, and supports multiple time-range assignments for each pen. The Chart Object also includes complete Proficy HMI/SCADA – iFIX object color and style properties for each pen, multiple X and Y axis configuration, and configuration and property adjustment in the Runtime environment. The Charting Object works with both the iFIX - Classic Historian as well as the Proficy Historian.

Reporting

Proficy HMI/SCADA – iFIX provides multiple reporting options. For example, data can be exported using SQL and ODBC connections into relational databases for extensive reporting.

When advanced reporting is required, couple Proficy HMI/SCADA – iFIX with the Proficy Real-Time Information Portal. It delivers reporting through the integration of multiple data sources, Real-Time, Historian and relational.

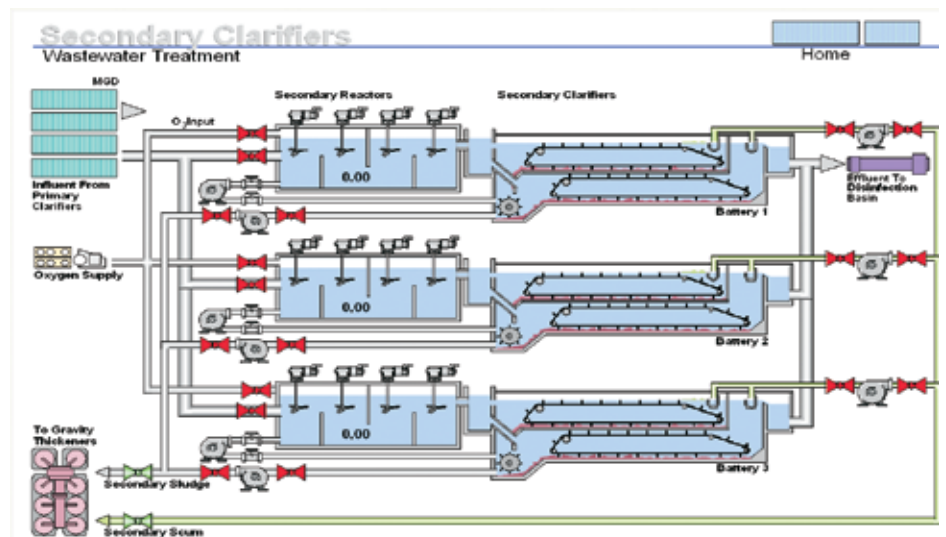

Proficy HMI/SCADA – iFIX Real-Time Display

The Proficy HMI/SCADA – iFIX chart object allows the ability to display real-time process data, historical and archived data, and lab data from a file or database. Users can customize properties, from colors to scroll directions, in either configure or run-time environments.

Proficy* HMI/SCADA – iFIX*

Advanced Alarming

Proficy HMI/SCADA – iFIX alarming enables users to create systems that report potential problems before they occur. Distributed alarm management provides unlimited user-named alarm areas, exception-based alarming, alarm priorities and filtering, alarm counters, and remote management of alarms through dial in/out management service. iFIX can also send non-critical operator messages that do not require a response.

Picture Caching

Picture caching can be enabled to maximize application performance. Cache size is completely configurable, and pictures can be preloaded upon startup. Flexibility is provided to enable/disable caching on a picture-by-picture basis. Picture performance is also maximized through “Screen Region” and Layers refresh technology that is only available in Proficy HMI/SCADA – iFIX.

Power and Connectivity

Since Proficy HMI/SCADA – iFIX is an open, scalable system built on industry-standard technology, it is more easily developed, integrated, and expanded than systems designed on proprietary technology.

OPC (Open Connectivity – Leveraging Microsoft OLE for Process Control)

Proficy HMI/SCADA – iFIX can act as an OPC Server to any standard OPC Client. Conversely, Proficy HMI/SCADA – iFIX can act as an OPC Client to any standard OPC Server. OPC in the Proficy HMI/SCADA – iFIX WorkSpace allows graphic animation directly from any OPC Server. Support exists for both OPC-DA (Data Access) and OPC-AE (Alarm and Event) specifications.

ODBC/SQL

Proficy HMI/SCADA – iFIX fully leverages the ODBC Application Programming Interface (API), adding the capability to collect and write realtime data and secure electronic records to one or more relational databases. Data can easily be moved between a relational database and the Proficy HMI/SCADA – iFIX process database.

Backup and Restore

The backup and restore Wizard in Proficy HMI/SCADA – iFIX allows users to pack up and go, helping them to manage their files and application projects. Once files have been selected for backup, the Wizard saves them to a compressed archive file in a defaulted or user-specified directory for use on any Proficy HMI/SCADA – iFIX-ready machine. Files can be restored as a whole project, or individually as needed.

Integrated Change Management

Proficy HMI/SCADA – iFIX delivers a fully integrated Change Management Client. Your decision to combine GE’s Proficy Change Management with your HMI/SCADA means you will benefit from completely automatic version management for all of your application files. Check files out, make changes, check them back in, all under complete version management and application security. Know who is working on what files. Be assured that you can revert back to any previous version. Know your files are safe and archived for Disaster Recovery purposes.

Secure Containment

Our Secure Containment technology ensures that the reliability of your graphics container isn’t compromised by an improperly functioning third-party component. Anomalies will be isolated, allowing the system to continue running without interruption. This helps prevent data loss, operator disruption and costly plant floor downtime. Secure Containment is only available from GE.

Building Custom Objects with VBA

Proficy HMI/SCADA – iFIX custom objects enable display tailoring through VBA. When an object initiates an edit event, VBA scripts can offer customization, delivering a new level of development productivity and setup reliability. Specifically, custom property pages can be modified, animations applied in real time, and animation code hidden in user forms. In addition, user forms can be placed into a global page so that every time the object is opened, the format for a particular property page is shared among many users.

Security

Proficy HMI/SCADA – iFIX synchronizes its security with standard Windows Domain Security. Proficy HMI/SCADA – iFIX security completely controls access to Proficy HMI/SCADA – iFIX programs, operator displays, schedules, and recipes. Access to critical program functions can also be restricted (for example, reloading the process database, or write access to the process database).

Redundancy

Proficy HMI/SCADA – iFIX addresses seamless system uptime through a variety of system features. Using a combination of backup SCADA servers, LAN and driver redundancy, and alarm management, Proficy HMI/SCADA – iFIX enables the development of extremely high reliability applications. In addition, Stratus High Availability Computing Platforms are fully qualified for use with Proficy HMI/SCADA – iFIX.

Capture Electronic Signatures

Standard signing dialog boxes provide a description of the action the operator is taking. The signer has the option to enter a comment from a pre-defined list or enter their own comments. Actions can also be configured to capture a verification signature. Signing dialogs can be tied to secure electronic records that will report who, what, when and why those actions were taken.

A Robust HMI/SCADA Solution

The ability to monitor and control plant-wide processes from a single location, while at the same time collecting and sharing real-time business information throughout the enterprise, has become a significant competitive advantage in today’s manufacturing and production environment. In searching for a way to maximize quality, increase productivity and reduce operating costs, the manufacturing world has turned to the heart of its operation – the plant floor. Companies around the globe who have done so successfully have turned to Proficy HMI/SCADA – iFIX from GE.

Whether it’s used as a stand-alone HMI/SCADA application or leveraged with GE’s Proficy Historian and other applications, Proficy HMI/SCADA – iFIX can help you turn data into information, empowering operators for dramatically improved performance.

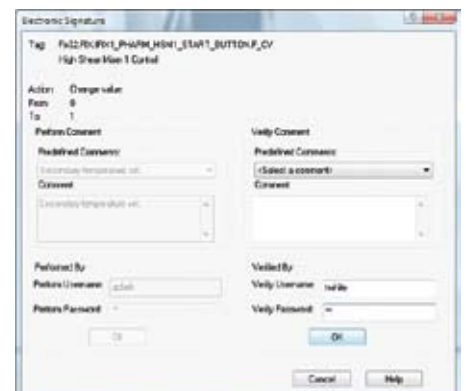

Capture Electronic Signatures

Standard signing dialog boxes provide a description of the action the operator is taking. The signer has the option to enter a comment from a pre-defined list or enter their own comments. Actions can also be configured to capture a verification signature. Signing dialogs can be tied to secure electronic records that will report who, what, when and why those actions were taken.

Proficy* HMI/SCADA – iFIX*

iFIX System Requirements

- IBM Pentium II 266MHz personal or industrial computer that runs Windows NT/2000/XP/Vista (Recommended Pentium 4, 1GHz)
- RAM Memory size: 96 MB RAM
- 120 MB hard disk
- CD-ROM drive
- SVGA or higher color monitor with 24-bit graphics card
- Pointing device
- Parallel or USB port
- Network adapter(s): NETBIOS-compatible or TCP/IP-compatible network interface adapter.
- No network adapter is required for standalone applications.

Proficy HMI/SCADA – iFIX Capabilities

- Monitor and control plant processes, equipment and resources
- Collect and share real-time and historical data with users on all levels of your business
- Respond faster to process conditions and market demands

GlobalCare – Total Service and Support

Complex business environments have complex support needs, and GE's GlobalCare Support offering is the best and most comprehensive way to optimize your investment. We developed GlobalCare Support to function beyond the scope of a traditional, reactive support model to provide you with fast, effective solutions throughout the product lifecycle. As a result, we provide a continuously high level of service for your complex support requirements. GE's GlobalCare

- Maximize plant effectiveness, increase productivity, and reduce cost and waste
- Benefit from a fully secure automation system that delivers 100% data integrity
- "Designed for 21 CFR Part 11" functionality for recording operator actions and building secure electronic records as defined by the FDA'S 21 CFR Part 11 Regulation

provides a consistent worldwide backbone of professionals that offer business hours and 24 x 7 emergency support, software version upgrades and advanced tools to keep you operational and productive. GlobalCare Support is available in two levels, Complete and Assist, allowing you to adopt the support solution that best meets your needs. To learn more about GlobalCare services or the full line of automation solutions from GE, visit ge-ip.com or call 1 800 433 2682 (Americas), +800 1 433 2682 (EMEA) and +86 400 820 8208 (APO).

Proficy Software Modules:

Real-Time Information Portal
[Proficy Real-Time Information Portal](#)

Plant Performance and Execution
[Proficy Efficiency](#)
[Proficy Production](#)
[Proficy Tracker](#)
[Proficy Machine Tool Efficiency](#)

Integrated Quality
[Proficy Quality](#)
[Proficy Non Conformance Reporting](#)
[Proficy Shop Floor SPC](#)

Process Solutions
[Proficy Process Systems*](#)
[Proficy Batch Execution](#)
[Proficy Batch Analysis](#)
[Proficy RX™](#)

Plant Data Repository
[Proficy Historian](#)

Asset Management
[Proficy Remote Monitoring & Diagnostic](#)
[Proficy Change Management](#)
[Proficy Maintenance Gateway*](#)

HMI / SCADA
[Proficy HMI/SCADA – iFIX*](#)
[Proficy HMI/SCADA – CIMPLICITY*](#)
[Proficy View – Machine Edition](#)

Programming & Control
[Proficy Logic Developer](#)
[Proficy Motion Developer – Machine Edition](#)

GE Support & Services:

[GlobalCare Support Professional Services Training](#)

About GE Intelligent Platforms

GE Intelligent Platforms, a General Electric Company (NYSE: GE), is an experienced high-performance technology company and a global provider of hardware, software, services, and expertise in automation and embedded computing. We offer a unique foundation of agile, advanced and ultra-reliable technology that provides customers a sustainable advantage in the industries they serve, including energy, water, consumer packaged goods, government and defense, and telecommunications. GE Intelligent Platforms is a worldwide company headquartered in Charlottesville, VA and is part of GE Home and Business Solutions. For more information, visit www.ge-ip.com.

GE Intelligent Platforms Contact Information

Americas: **1 800 433 2682** or **1 434 978 5100**

Global regional phone numbers are listed by location on our web site at www.ge-ip.com/contact

www.ge-ip.com



©2010 GE Intelligent Platforms, Inc. All rights reserved.
All other brands or names are property of their respective holders.
Specifications are subject to change without notice.



01.10 GFA-562D